

Задание №1 «Плоский контур»
Вариант №30

1

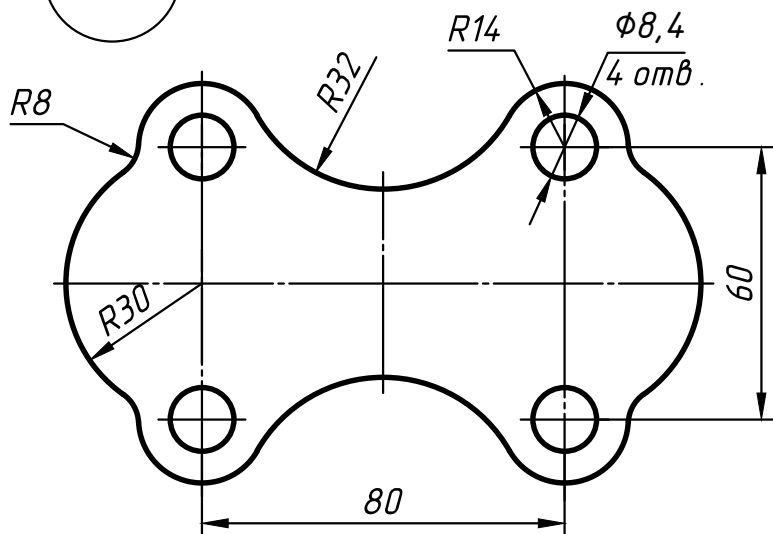

2

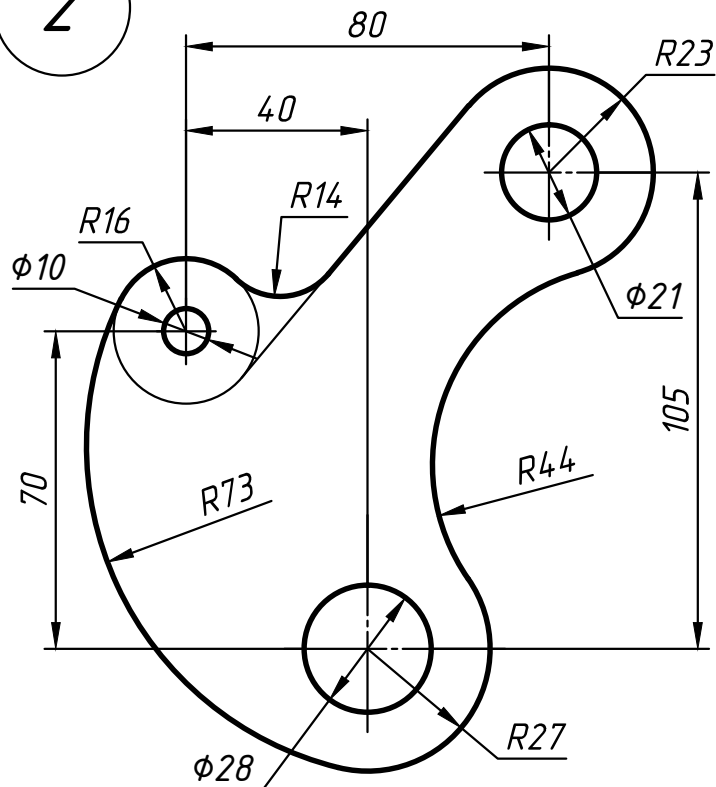

3

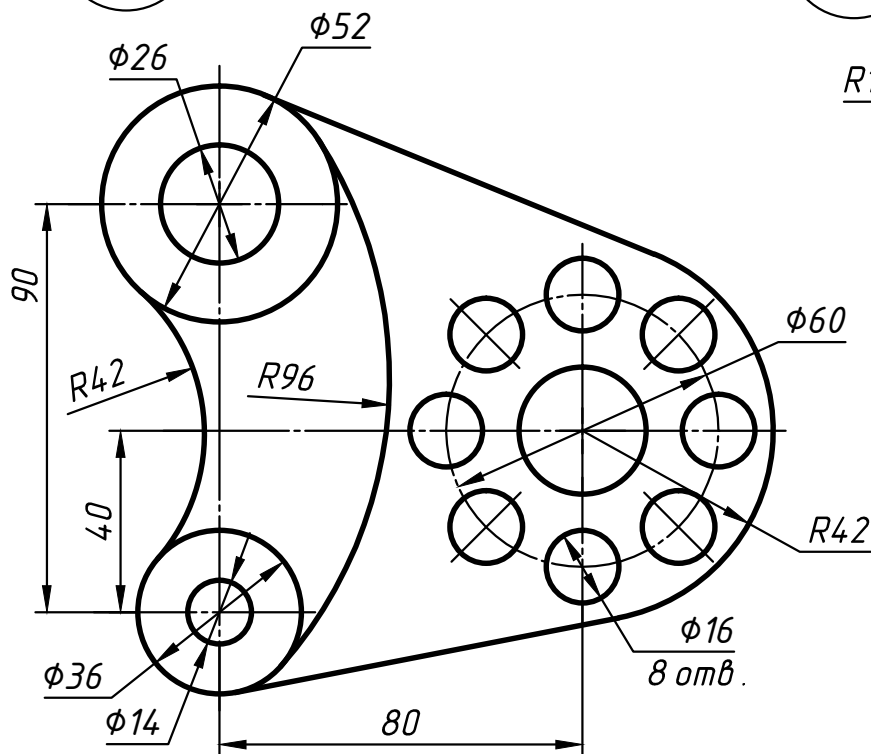

4

