

Задание №1 «Плоский контур»
Вариант №12

1

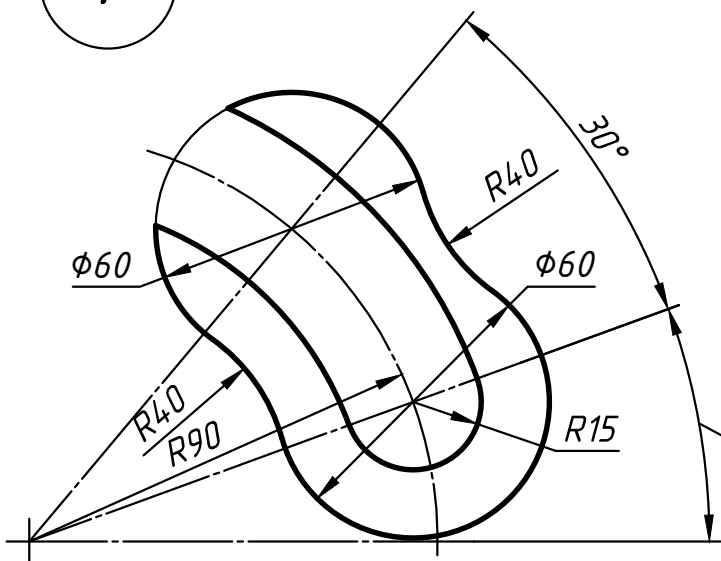

2

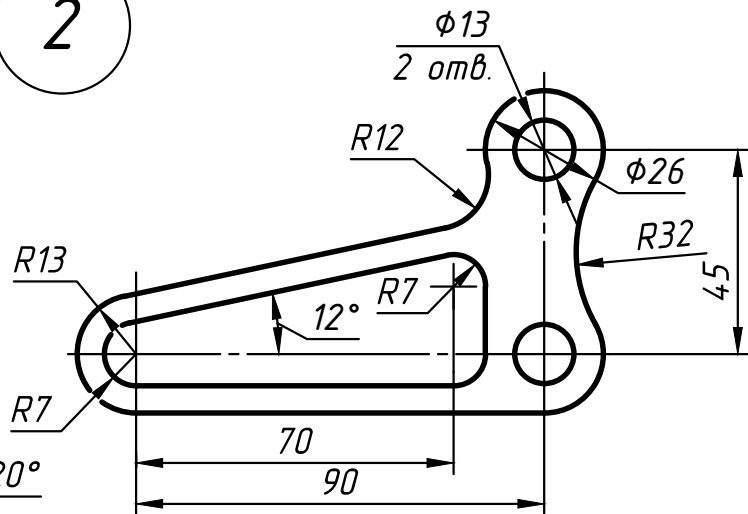

3

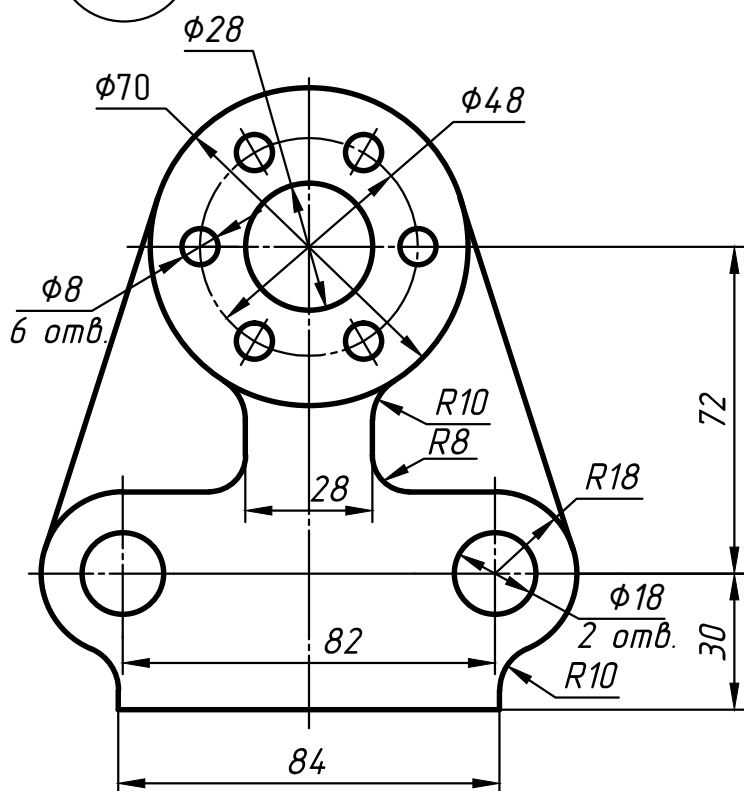

4

